

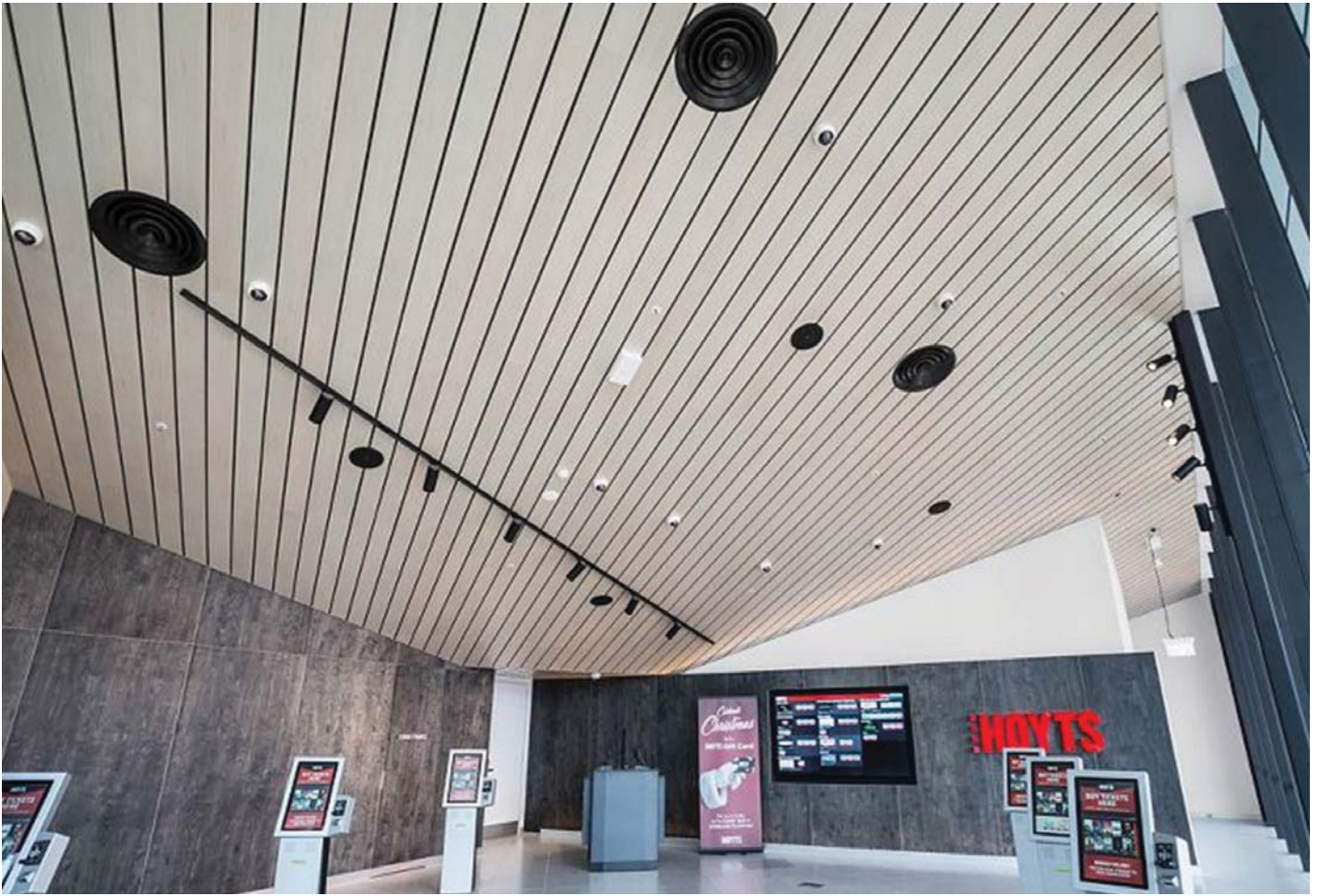

## ARMSTRONG METALWORKS™ F-PLANK

- Flexibility is the key with METALWORKS F-Plank, which combine a range of profile and colour options with the a sophisticated linear visual
- Acoustical options with microperforated panels
- Three Profile widths: 100, 200 and 300mm (nom) including a 20mm reveal
- Fast and easy installation
- Durable – Washable, Scrubbable, Impact-resistant, Soil-resistant Typical Applications

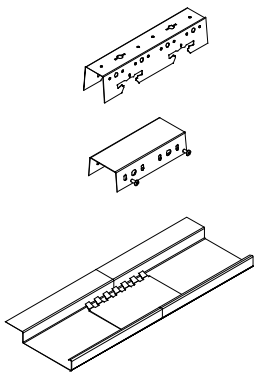

### Suspension Accessories

	Item Number	Description	Dimensions (mm)
	BP5497M	Carrier Rail	40 x 40 x 3000
	BP5499M	Carrier Rail Joiner	38 x 16 x 100
	BP5495M	100mm Panel Splice Plate	100
	BP5496M	200mm Panel Splice Plate	200
	BP5575M	300mm Panel Splice Plate	300

### Perimeter Trim

		Panel end cap available on request (for Floating Ceiling Application)	
	AC-WM-2023	Aluminium Wall Angle	20 x 23 x 3000
	AC-WM-203020	C-Wall Molding	20 x 30 x 20 x 3000
	AC-PC-203020	C-Wall Molding Pressure Spring	-

For wider range of perimeter trim option, please contact your local sales representative.



## Installation Detail

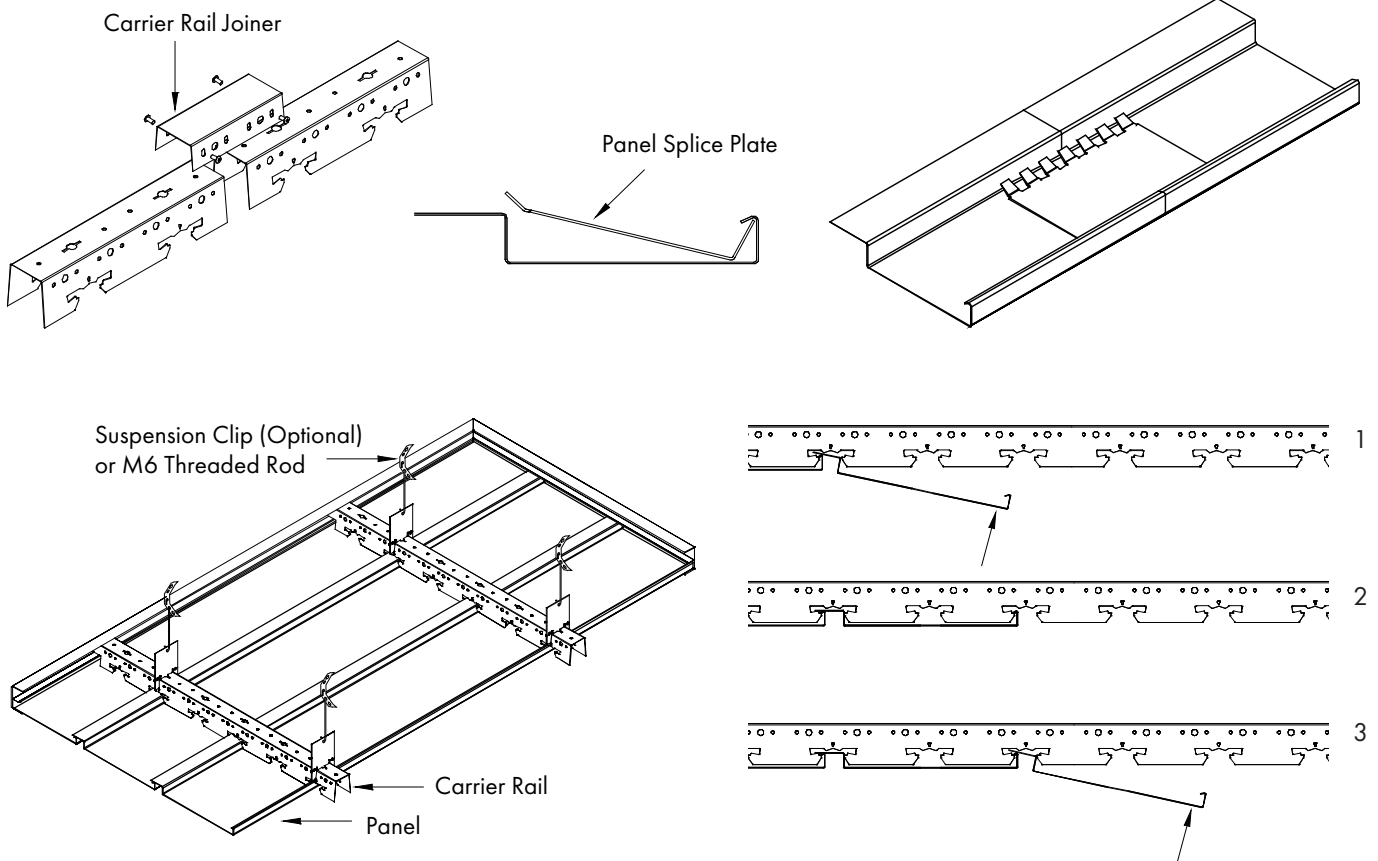









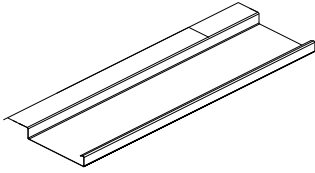
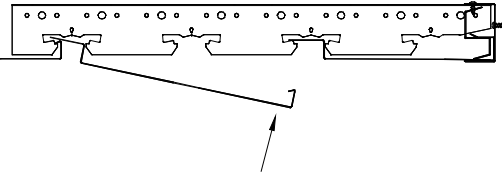



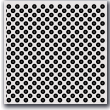





METALWORKS F-Plank are simply raised into position and clicked into the Carrier Rail.

Refer to the METALWORKS F-Plank System Components and also the Assembly and Installation Instructions for more details.

# ARMSTRONG METALWORKS™ F-PLANK



Panel Options	F-Plank: Liner Strip Ceiling System with Reveal – Interior Application	
 <b>Edge details</b>	  <p data-bbox="448 521 927 548">Square with Extended Flange / Aquiline hook-end</p>	
 <b>Material</b>	Galvanized Steel 0.7mm	
 <b>Patterns</b>	  <p data-bbox="448 790 703 817">Plain Non Perforated (M1)</p> <p data-bbox="767 790 991 817">Micro Perforated (M2).</p> <p data-bbox="767 822 1501 848">* Micro perforated panels feature an unperforated border and include acoustical fleece.</p>	
 <b>Dimensions (mm)</b>	<p data-bbox="448 880 794 907">F100 : 100 (W) x 2400 / 3000 (L)</p> <p data-bbox="448 913 794 940">F200 : 200 (W) x 2400 / 3000 (L)</p> <p data-bbox="448 947 794 974">F300 : 300 (W) x 2400 / 3000 (L)</p>	
 <b>Weight</b>	8.07 kg/m <sup>2</sup>	
 <b>Colour</b>	<p data-bbox="448 1086 842 1113">Polyester Powder Coated – Global White</p>  Wood Effects Available by Request	
 <b>Sound absorption</b>	Up to NRC 0.70 (Perforated Option with fleece, without additional infill)	
 <b>Sound attenuation</b>	Approximately 18 dB	
 <b>Fire reaction</b>	CLASS 0/1 based on BS 476 Part 6 & 7	
 <b>Accessibility</b>	<p data-bbox="448 1355 938 1382">Limited Accessibility, Access hatch may be required.</p> <p data-bbox="448 1386 1219 1413">F-Plank is non-demountable, suitable to be applied for secured ceiling application</p>	
<b>Durability</b>		
<b>Cleanability</b>	  	
 <b>Sustainability</b>	 <p data-bbox="560 1659 995 1733">Knauf Armstrong provides the widest range of products that have been third party tested and certified by industry leading Eco-classification</p> <p data-bbox="464 1738 517 1765">25%</p>	

All sizes are nominal. Product availability may vary.



SCAN & EMAIL ME

## Contact